

JAYS COMPANY

Providing the Professional Edge Since 1970

www.jayscompany.com

2021

Forms & Supplies

CATALOG

Inside You Will Find:

- Forms, Statements, Envelopes & Med Sheets
- Name Badges, Name Plates, Signs & Stamps
- Rx Blanks, Checks, Stationery & Manuals
- Floor Matting, Compounding & Pharmacy Equipment
- Controlled Substance Books & Tape

LOCAL 763-557-0056 FAX 763-557-0165 • TOLL FREE 800-647-5297 FAX 800-547-0165

OTHER CATALOGS TO ORDER FROM

ADVERTISING & DOSING
SUPPLIES

LABELS

PACKAGING



Welcome to Jays Company!

As a distributor for more than 50 companies we are your one-stop resource offering...

A Complete Line of Products You Need, At Prices You'll Love, With Service You Deserve.

Jays Company is a customer driven forms and label company dedicated to one simple mission: To develop and maintain a solid ongoing relationship with our customers. We strive to do that by delivering the right information and products in a timely manner at the right price. The result is helping you present a professional edge and making us both successful.

As you look through our new catalog sections, you will notice that we carry more than custom labels and forms. We are a distributor for more than 50 companies, which allows us to offer a complete line of many products. These products range from stock and custom medical labels and tapes, laser and thermal labels, pharmacy supplies, paper and plastic bags, unit dosing systems, advertising products and much more.



Looking for something not shown in our catalog? Give us a call, we would be happy to find it for you.

Thank you for taking the time to look through our catalog and please know that we will work hard to earn your business by having a helpful office staff, knowledgeable sales force and offering the best service in the industry. We sincerely thank you for the opportunity to serve you.



Your Friends at Jays Company

Forms & Supplies

- Computer Statements & Envelopes 5
- Custom Stationery, Envelopes, Business Cards 6
- Register Forms, Sales Receipts,
Charge Slips & Med Sheets 7
- Controlled Substance Books, Manuals and Supplies 8
- Prescription Blanks 9
- Prescription Files and Supplies 10
- Prescription Label Tape/
Pharmacy Dispensing Equipment 11-12
- Graduates & Compounding Equipment 13-14
- Name Badges, Name Plates & Signs 15
- Custom Stamps 16
- Anti-Fatigue Floor Matting 17
- Pharmacy Retrieval System 18

Advertising & Dosing Supplies

- Magnets & Clips
- Calendars & Wallet Cards
- Travel & Health Items
- Candy & Breath Fresheners
- Drinkware & Outdoor Specialties
- Bags & Totes
- Dosing Supplies

Labels

- Custom Rx Labels
- Thermal Rx Labels
- Laser Rx Labels (All Pressure Sensitive)
- Laser Dual Web Rx Labels
- Laser Paper Rx Labels
- Labels for Automated Systems (Robot)
- Long Term Care Rx Labels
- Patient Compliance Labels
- Specialty Labels
- Miscellaneous Blank Labels
- Mailing Labels
- Veterinary Labels
- Custom Label Checklist

Packaging

- Custom Printed Paper Bags
- Stock Pharmacy Bags
- Custom & Stock Paper Bags
- Custom & Stock Plastic Bags
- Packaging & Shipping Supplies
- Mailing Supplies & Stamps
- Vials, Jars & Ovals
- Unit Dose Pill Cards & Supplies



General Information

Artwork Requirements

We accept artwork and logos via email. Artwork must be created in one of the Adobe programs listed below. Other programs may be used providing they can export output which can be read by these programs. Note: files created by “paint” programs are not usable.

Adobe Illustrator: Versions

EPS
Photoshop PSD
Adobe PDF
JPEG

Proofs on Printed Orders

A proof on all new orders will be sent to you via email, fax or postal mail. When proofing, please be sure that you check all spelling, logos, punctuation, phone numbers and placement of copy. We cannot be responsible for orders approved by the customer that contain incorrect copy.

Shipping

If no specific carrier is requested then all merchandise is always shipped in the most affordable and reliable way. Upon receiving, all orders should be checked for damage. All claims for damaged merchandise should be filed with the carrier. Many items are stocked in our warehouse and will ship the same or next day.

Damaged Shipments

Although we work hard to ensure that all shipments are received without damage, it does sometimes occur. If you receive a shipment that is damaged, sign for the shipment noting all damages on the signature page. Then contact us at Jays Company so we can assist with the claim process.

Return Policy

Please call us if you receive merchandise or items that you wish to return. We will make arrangements at that time and you will be given an RMA number (Return Merchandise Authorization). A restocking fee may apply to stock merchandise.

Sales Tax

All taxable merchandise will be subject to state and local sales taxes.

Computer Statements and Envelopes

Laser Statements & Envelopes

Statement	Qty	Envelope	Qty
SMLMK	500/Pkg	EVLMK	500/Box
SMLQ	500/Pkg	ENVQS1	500/Box
STATEONRX30	500/Pkg	ENVIN301 & ENVQS1	500/Box
NDCLSM	500/Pkg	EVJVP & NDCLEV	500/Box
HM-STATE	500/Pkg	EVLMK	500/Box



SMLMK



SMLQ



STATEONRX30

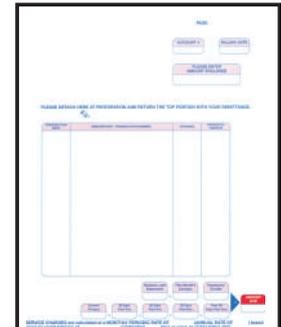

NDCLSM



Custom and “hard to find” statements available in laser.

Please call Jays Company for more information.

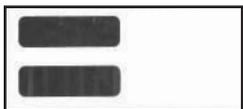

ENV3PM



ENVIN301

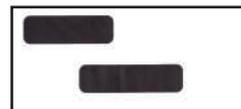

ENVQS1

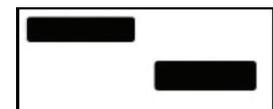

EVLMK



Custom Stationery, Envelopes,
Business Cards, & P.O.S. Thermal Paper rolls

Custom Stationery

Your stationery package reflects your professional image and we can help you determine the best style and paper stock for your budget. Count on us for business cards, stationery and second sheets, envelopes with the option of windows, courtesy note cards and more!

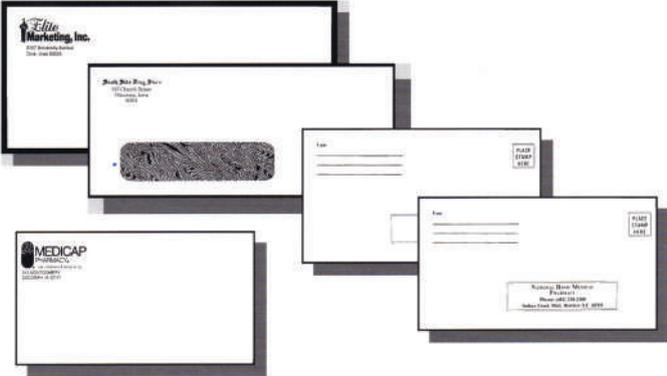

Featuring:

Fast Delivery – Most orders will be filled within five working days.

Give Us A Sample – Send us a sample of your current stationery or a detailed sketch of your concept along with an electronic file of your logo. Once we establish your requirements, we can give you a price quote.



P.O.S. Thermal Paper Rolls

Item # 312220T-J
3 1/8" x 220'
50 rolls/case



*Call your representative
for information
on the many sizes
of envelopes!*

*Other sizes available
can be customized!*

Register Forms, Sales Receipts, Charge Slips

Many sizes and formats of register forms are available.
Duplicate or triplicate carbonless with or without numbering.

Please send or fax us a sample and we will assist you with all of your requirements.



We can customize these forms for you!



Med Sheets

Jays Company offers a wide variety of med sheets and physician order forms to economically fit your needs. You'll receive individual attention to match your software requirements and format. While we stock the most popular standard med sheets, we welcome the opportunity to create a sheet specific to you. Call us and ask for our custom med sheet expert!

Medication Administration Records & Physician Order Forms

Shown here are a variety of popular pharmacy medication administration records and physician order forms which are compatible with most major software systems. Call us for details.

Note: Standard backer on most forms

Form JAS-1/L

Form JV3/L

Form JMAR-D-AL

Form JV1-L

Form JAO-3/ML

Controlled Substance Books, Manuals and Supplies

Sold individually, no minimum quantity

Item	Description
NARC-BK	Individual Narcotic Log Book
NARC-BK-DAILY	Daily Narcotic Log Book
NARC-BK-DETOX	Daily Narcotic Log Book
NARC-BK-LDN	Daily Narcotic Log Book With Listed Drug Names
JREGPS06	Pseudoephedrine Log Book
JREGS	Syringe and Needle Log Book
RXREGP	Poison Control Register

Additional pharmacy manuals are available.

Tamper Proof Tape

Self-evident tamper-proof tape in rolls provides protection on all bottles and containers as well as boxed items. One-half inch by 72 yards.



TAMPER-CLEAR.5	1/2" X 72 YARDS
TAMPER-RED.5	1/2" X 72 YARDS
TAMPER-RED1	1" X 108'
TAMPER-STRIP	1.5" X 6.5"

Security Seals

Many styles, colors and consecutively numbered options available including:

Aluminum Lock & Link Seals	Preprinted Seals	Tamper Evident Seals
Barcoded Seals	Pull Fly® Baby Seals	Tamper Evident Tip Caps for Luer Lock
Biohazard Seals	Pull Tight Padlock Seals	Syringes
Custom Printed Seals	Pull-Tite II® Seals	Tamper Evident Tip Caps for Oral
Draw Tight Seals	Ring-Pull® Seals	Syringes
Heavy-Duty Pull Grip Seals	Secur-Pull® Seals	Tear Away Seals
Ladder Lock Seals	Split-Lock Wire Padlock Seals	Tote Seals



Individual



- Hardbound cover
- Sewn binding
- 4 Index pages
- 160 Individual log pages
- Used by LTC facilities
- Item Code: **NARC-BK**

Daily

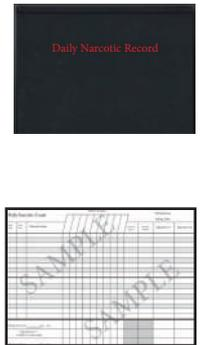

- Hardbound cover
- Landscape page layout
- 91 Daily log pages
- 9 narcotic entries per page
- Used by surgery centers
- Item Code: **NARC-BK-DAILY**

\$39.00
per book

* To view PDF pages please call us or visit www.jayscompany.com and click on NARCOTIC BOOK*

You may customize the Narcotic Log Book with your own company logo

10 Log Books @ **\$45.00/book**
\$35.00 one-time set up fee

25 Log Books @ **\$35.00/book**
\$35.00 one-time set up fee

4-6 Weeks for processing • Please call Jays for more details

“C” Stamp

Sold individually.

Item	Description
JCST	C Stamp – red
JCSTII	CII Stamp – red



Stock Prescription Blanks

All of our stock prescription blanks are manufactured on 20 lb. white bond paper and printed in blue ink. Forms are padded in 100's – ten pads per bundle of 1,000 – shrink wrapped.

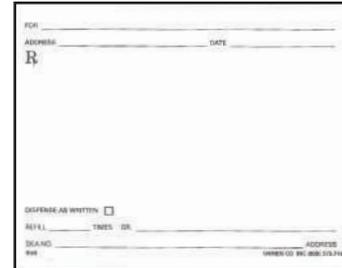

Stock Tamper Resistant Blanks

Item	Description	Qty/Package
15000TR	4 ½" x 5 ½"	1,000
15100TR	8 ½" x 11" (one up/perforated)	1,000
15101TR	8 ½" x 11" (4 up/perforated)	1,000
15102TR	8 ½" x 11" (no perf/no back print)	1,000
15103TR	8 ½" x 11" (no perf/with back print)	1,000

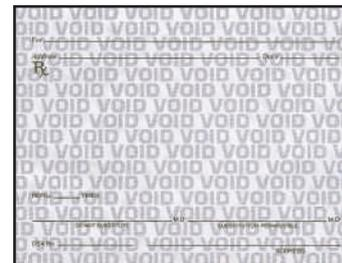

Personalized Prescription Pads

These blanks are printed with any information you desire, supplied in tabbed pads of 100. Blue ink on white 20 lb. bond paper.

Options: Additional ink colors are black, red and dark blue. Hole punching and 2-part carbonless forms are also available.

Custom Tamper Resistant Prescription Pads (Security Paper)

Item	Description	Qty/Package
1905TR	4 ¼" x 5 ½"	100 per pad/3,000
1905TR-2	2-part, 4 ¼" x 5 ½"	100 per pad/3,000
19401TR	8 ½" x 11" – 1 up	3,000
19404TR	8 ½" x 11" – 4 up	3,000

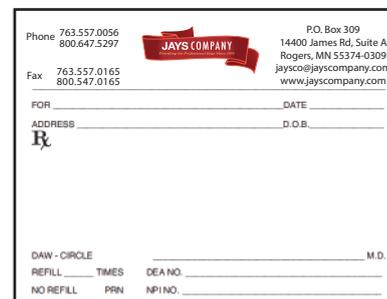

1905TR

State Specific Prescription Pads

Many states require a specific form. Call us and we will provide the form for your state.

California Style Folders

Featuring 12 " x 6 " size with two extended folds; wrap completely around your prescriptions. Each folder holds 100 prescriptions. Available in packages of 100 in the following colors: buff, blue, dark pink, green, cherry red, and "assorted" which is a combination of 25 of each the four colors. Made of sturdy, 140 lb. index stock for heavy use.

Item	Size	Qty/Pk
CALIF	12 " x 6 "	100

Unfolded Dim



Western Style Folders

Single-fold prescription file folders. Available in buff color only.

Item	Size	Qty/Pk
West no tab	9 " x 6 "	100
Tab2 with tab	9 " x 6 "	100

Texas Style Folders

Pre-scored for easy folding.

Item	Size	Qty/Pk
Texas	5 ½ " x 4 " x 1 "	100

Folded Dim

Cardboard File Drawers

An economical answer to your storage problems, these lightweight corrugated drawers can be used to store records. They may be stacked for even more efficient use of space. White only.

Item	Size	Description
AP50042	13 " W x 5 " H x 17 ¼ " D	Deep single drawer with divider
AP50040	7 ¼ " H x 5 ¼ " W x 17 ¼ " D	Deep single drawer – no divider



Rx Organizer

Strong plastic box with interchangeable dividers held in place by notches. Dividers feature raised portion for easy labeling. (Item: RXORG)

Staplers and Staples

Item	Description
Plier	Bostitch Plier Stapler
B8S	B-8 Bostitch Staples



Other staplers and staples available, please call for details. We offer stand-up, electric and rapid.

Prescription Tape Dispenser

Durable, weighted prescription tape dispenser.
Replacement cutting blades available. Sold individually.

Item	Dimensions
C22	2" tape dispenser, table top

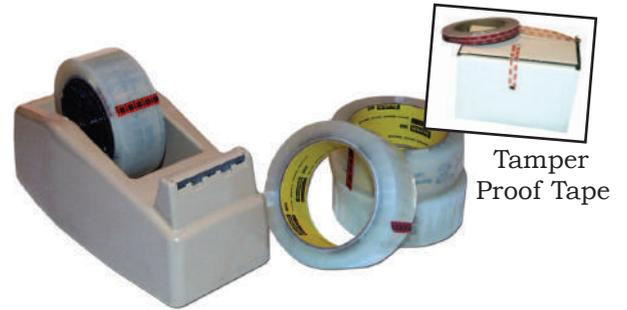

Tamper Proof Tape

3M™ Prescription Tape

Item	Dimensions	Qty
3M1	1"	Rolls
3M15	1 ½"	Rolls
3M175	1 ¾"	Rolls
3M2	2"	Rolls

Generic Prescription Tape

Top quality, affordable, clear tape with an acrylic adhesive backing. Perfect for label protection.

Item	Dimensions	Qty/Case
TAPE1.5X72	1.5" X 72 yards	48 rolls
TAPE1.75X72	1.75" X 72 yards	42 rolls
TAPE1X72	1" X 72 yards	72 rolls
TAPE2X72	2" X 72 yards	36 rolls

Reconstitube®

Graduated system for diluting antibiotics. This kit contains all mounting equipment, siphon hose, shut-off clamps and adapter connection.

Item	Description
AP25001	Original Reconstitube Kit
AP24950	Deluxe Model with Pinch Valves



Original



Deluxe

**Need to Pass
Inspection? We
Offer Pharmacy
Equipment &
Supplies Kits**



Replacement Parts for Reconstitube®

Item	Description
AP25096	White Vinyl Tubing, 52"
AP24955	Ezy Dose Pinch Valve

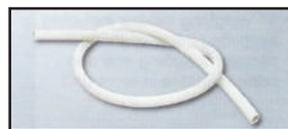

Pill Counting Tray

An easy way to sort, count, and organize pills for all your facility needs! Comes with an angled spatula.

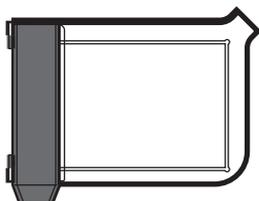

White Filter Paper

White, round filter paper available in packs of 100.

Powder Papers

Blank, white powder papers in packs of 500.

Description	Size	Qty
Parchment	4" x 4"	100/pkg
Glassine	3" x 4"	500/pkg
Glassine	4" x 4"	500/pkg

Please call for other sizes.

Parchment Ointment Pads

Greaseproof, sanitary parchment paper ointment pads. 100 sheets per pad.

Description	Size
Ointment Pad	12" x 12"

Ointment Compounding Slab

Description	Size
Heavy Glass Slab	12" x 12" x 3/4"
Regular Glass Slab	12" x 12" x 1/4"

Six-in-One Tool

Performs six tasks easily – pulls cotton, scrapes labels, cuts tape, cuts pills in half, opens cartons and counts tablets. A must for every pharmacy.

AP68721 Six-in-One Tool

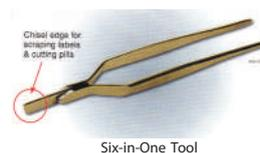

Rx Tool – Safety Cap Remover

Ends aggravation trying to remove childproof caps. Sturdy steel with plastic handle cover.

Item	Description
AP23298	Rx Vial Cap Opener

The "Hook"™

Great for counting, cutting seals and removing cotton.



Pill Tile

Glass, scored pill tile 10" x 12"

Spatulas

Available with either straight or tapered, stainless steel blades, or heavy duty rubber.

Steel Spatulas with Straight Blade

Sizes: 4", 6", 8", 10", 13"

Steel Spatulas with Tapered Blade

Sizes: 4 1/2", 5 1/2"

Hard Rubber Spatulas

Sizes: 4", 6", 8"

Size is length of blade only

Glass Graduates

Available in both conical and cylindrical configurations. Manufactured from finest soda lime glass. Sold in eches.



Double Scale Glass Conical Graduates, metric and ounces

Size

- 5 ml (1dr/60 min)
- 10 ml (2dr/120 min)
- 25 ml (1 oz)
- 50 ml (2 oz)
- 100 ml (4 oz)
- 250 ml (8 oz)
- 500 ml (16 oz)
- 1000 ml (32 oz)

Plastic Graduates

Available in both conical and cylindrical configurations. Sold in eches.

Graduated Plastic Conical Graduates, metric and ounces

Size

- 50 ml (2 oz)
- 100 ml (4 oz)
- 250 ml (8 oz)
- 500 ml (16 oz)



Graduated Plastic Cylinders, metric only

Size

- 25 ml
- 50 ml
- 100 ml
- 250 ml
- 500 ml
- 1000 ml



Graduated Glass Cylinders, metric only

Size

- 5 ml
- 10 ml
- 25 ml
- 50 ml
- 100 ml
- 250 ml
- 500 ml
- 1000 ml



Electronic Scale

Meets most state's board requirements.



EK-1200 I

Sensitive and accurate. 900 grain/57 gram capacity. Accurate to 0.1 grain/0.01 gram.

**Mortar & Pestles
 (Ceramic and Glass)**

Sold as sets or individually.

Ceramic Mortar & Pestle Sets

Capacity

- 2 oz.
- 4 oz.
- 8 oz.
- 16 oz.
- 32 oz.



Porcelain and Wedgwood sets also available.

Glass Mortar & Pestle Sets

Capacity

- 2 oz.
- 4 oz.
- 8 oz.
- 16 oz.
- 32 oz.



Glass and Plastic Beakers

Size

- 50 ml
- 150 ml
- 250 ml
- 400 ml
- 1000 ml



Glass and Plastic Funnels

Size

- 2 oz.
- 4 oz.
- 8 oz.
- 16 oz.
- 32 oz (special order)



Glass Stirring Rods

Glass rods with rounded ends – meets all federal requirements.

Size

- 8"
- 10"
- 12"



*Find a copy of
 our pharmacy
 check list in
 the back of
 this catalog*

Name Badges

Name badges create a first impression so make it count! It's your chance to engage your audience and enhance your brand.

Fully Engraved

Your logo and personalization are engraved into 2 ply plastic, available in an array of styles and color combinations.



Fully Engraved



Full Color

Imprinted

This process allows for clear solid color imprinting on a variety of colored plastics.



Imprinted

Full Color

The vivid colors of a full color name badge leave a great impression. Images are reproduced with photographic quality.



Fastener Options

All name badges are available with your choice of pin, bulldog/swivel clip, magnet or pocket clip fasteners.



Name Plates

We offer two styles of name plates: desk signs with holders and wall signs with mounting options of 2-sided tape, screw holes, Velcro® strips, magnetic tape and suction cup. Choices include: engraved stock plastic in a variety of colors with metal framing for desk or wall in silver, gold or black. Full color nameplates for desk or wall frames. Solid walnut block desk signage with plastic or brass nameplate.



Signs

We offer stock and custom signs and can recommend the most functional and economical choices for you. Stock signs are available in many sizes for ADA compliance, safety and utility.

Custom signs are available in engraved, raised vinyl lettering, sublimation and full color options. Many sizes and color combinations are possible.

Call us and we will help you find the right signs, name badges and name plates at the right price.



Self-Inked, Pre-Inked and Rubber Stamps

Square, round and rectangle stamps available in a variety of sizes: $\frac{3}{8}$ " x $\frac{3}{8}$ " up to $1\frac{7}{16}$ " x $2\frac{3}{8}$ ".



JAYS COMPANY
 14400 JAMES RD, SUITE A
 P.O. BOX 309
 ROGERS, MN 55374-0309

Ink Colors

To support the stamps, we offer re-inking systems and pads. We also offer notary stamps. Please call Jays Company for details.

Ink color options

-  Black
-  Red
-  Blue
-  Green
-  Violet

Font:

- 1 Swiss
- 2 Open Face
- 3 Bold
- 4 Heavy Bold
- 5 Times
- 6 Times Bold
- 7 Zapf Chancery
- 8 Lydian Cursive
- 9 Old English
- 10 Brushed Script
- 11 Architect
- 12 Parisian
- 13 Park Avenue

Size:

- 00 Fill Mount
- 08 8 pt.
- 10 10pt.
- 12 12pt.
- 14 14pt.
- 18 18pt.
- 24 24pt.
- 36 36pt.
- 48 48pt.

Example:

Font + Size
 9 48 = 
 Format 948
 Old English with
 48 pt. Lettering

Text Style:
 Upper/Lower
 ALL CAPS

Centered Flush Left Flush Right

Border
 Single line border framing the impression area

Red "C" Stamps

JCST C Stamp – red
 JCSTII CII Stamp – red

Other Stamps Available:
 Date/Number Stamp
 Notary Stamp



P1 3/8" X 1-9/16" Up to 4 Lines

P3 5/8" X 1-15/16" Up to 5 Lines

P5 1" X 2" Up to 8 Lines

P11 1-1/2" X 2-7/16"

P15 7/8" X 2-3/4" Up to 8 Lines

P17 11/16" X 3-3/8"

P43 1" X 4"

Anti-Fatigue Floor Matting, Solid Rubber with Smooth or Bubble Surface

These true ergonomic mats are industry specific for people standing for an extended amount of time. Leads to better productivity and overall job satisfaction. Available in many designs.

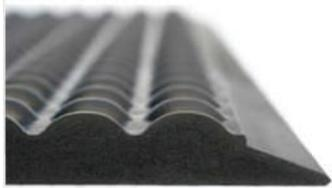

Classic, Complete Bubble, Basic Bubble

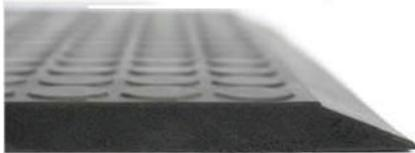

Complete Smooth, Basic Smooth

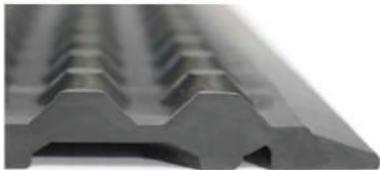

Nitril, Nitril ESD, Hygiene, Basic Nitril

Any Size, Any Shape!

Just give us a call with the area measurement you wish to cover and we will quote you a price. While standard sizes may meet your needs, affordable custom sizes are our specialty.



Hog Heaven



Hog Heaven Fashion



Waterhog Classic



Rubber Top with Foam Rubber Base

A great choice for long-term wear. Excellent comfort is provided by a 3/32" thick rubber surface bonded to a natural foam rubber base. Features a smooth surface with beveled edges for safety. Available in a variety of standard sizes, plus custom design sizes can be made.

Marble Colors:

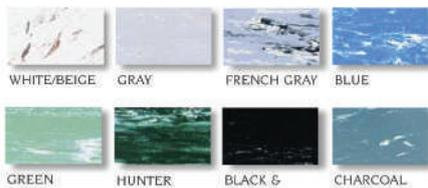

Solid Colors:



Evolving Styles™:

WOOD ELEMENTS



CREATIVE ELEMENTS



Retrieval Bags

Item	Size	Qty/Pack
HU101-J	10" x 7 1/2"	10
HU103-J	12" x 9"	10
HU104-J	10" x 12 1/2"	10
HU105-J	14" x 12 1/2"	10
HU107-J	14" x 21"	10
HU109-J	16" x 25"	10
HU111-J	20" x 25"	10
HUIDGP-J	Pack of 25 Letters	Each
HUCADDY-J	Bag Caddy	Each

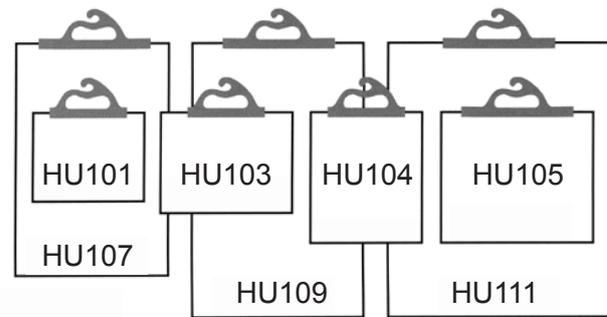
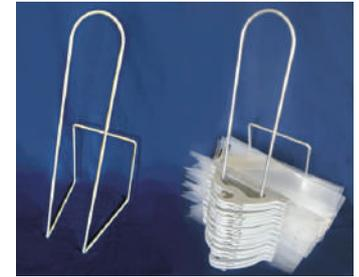

Standard Wall Racks

24", 48" or 72" vertical wall stands available.
24", 29", 36" and 48" rod available.

Item	Description	Qty
HUSR2.2	4' wide with 2 rods	Unit
HUSR3.3	3' wide with 3 rods	Unit
HUSR3.4	3' wide with 4 rods	Unit
HUSR3.5	3' wide with 5 rods	Unit
HUSR4.4	4' wide with 4 rods	Unit
HUSR4.5	4' wide with 5 rods	Unit

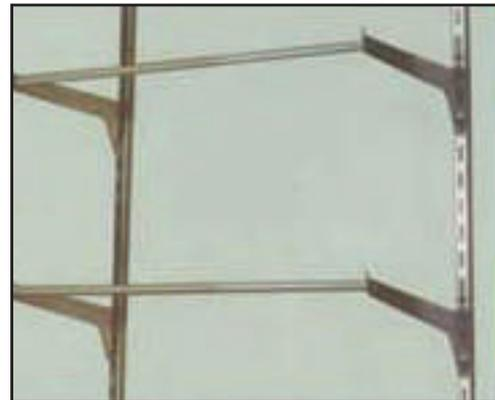

Rod Assembly

Item	Description	Qty
RETRIEVALRA3	3 foot - 1 rod, 2-8" arm bracket	Unit
RETRIEVALRA4	4 foot - 1 rod, 2-8" arm bracket	Unit

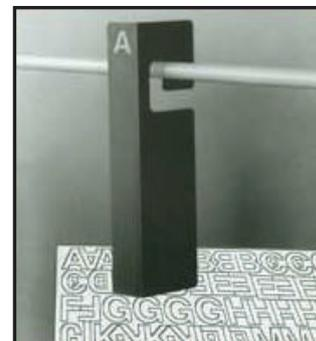



NOTES

Lined area for taking notes, consisting of 25 horizontal lines.

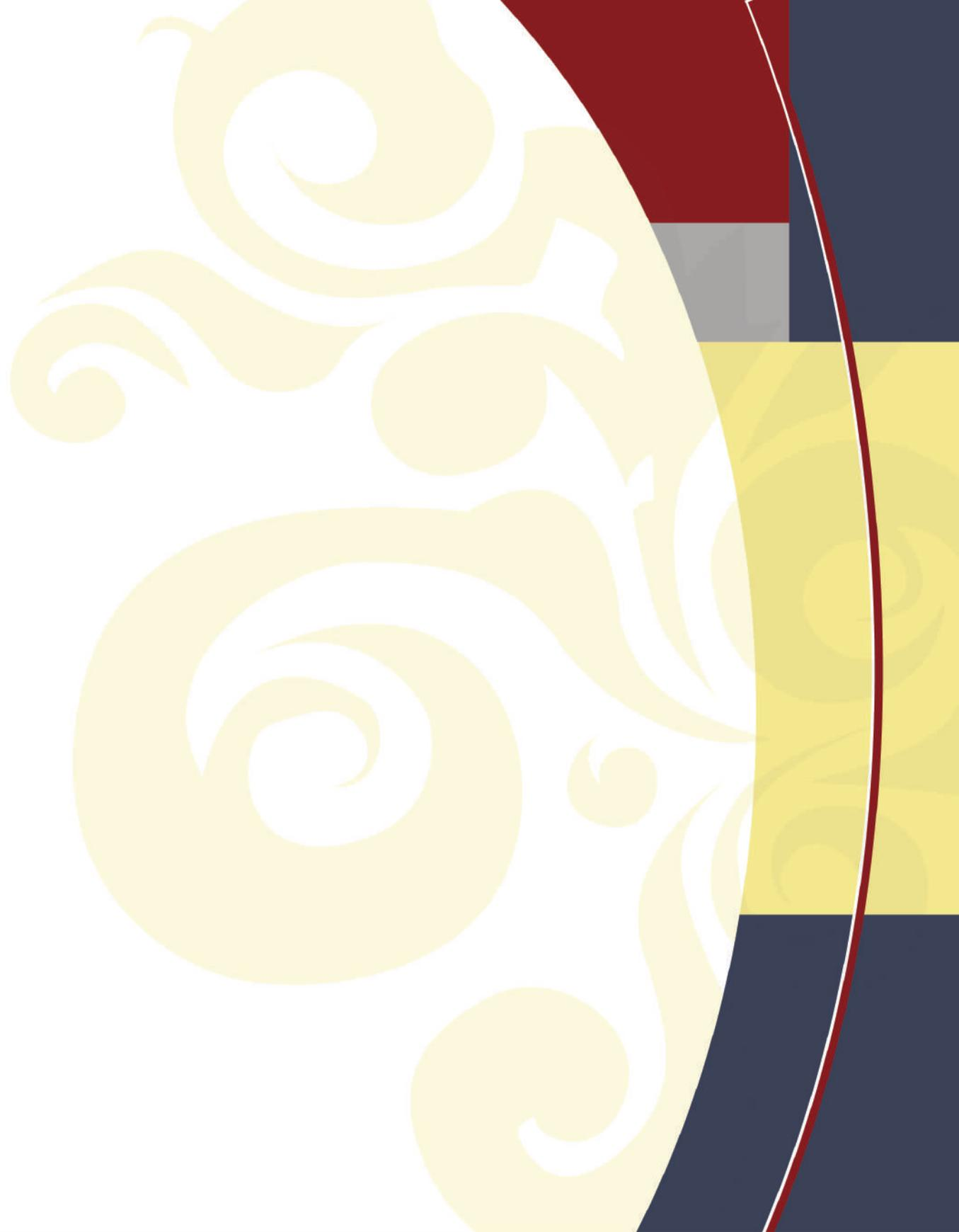

Jays Company
14400 James Road
PO Box 309
Rogers, Minnesota 55374-0309
1-800-647-5297 or 763-557-0056
Check us out on the web as well!