

JAYS COMPANY

Providing the Professional Edge Since 1970

www.jayscompany.com

2021

Packaging

CATALOG

Inside You Will Find:

- Bags, Paper & Plastic
- Packaging & Shipping Supplies
- Vials, Jars & Ovals
- Unit Dose Pill Cards & Supplies

LOCAL 763-557-0056 FAX 763-557-0165 • TOLL FREE 800-647-5297 FAX 800-547-0165

OTHER CATALOGS AVAILABLE

FORMS & SUPPLIES

ADVERTISING & DOSING
SUPPLIES

LABELS



Welcome to Jays Company!

As a distributor for more than 50 companies, we are your one-stop resource offering...

A Complete Line Of Products You Need, At Prices You'll Love, With Service You Deserve.

Jays Company is a customer driven forms and label company dedicated to one simple mission: To develop and maintain a solid ongoing relationship with our customers. We strive to do that by delivering the right information and products in a timely manner at the right price. The result is helping you present a **professional edge** and making us both successful.

As you look through our new catalog sections, you will notice that we carry more than custom labels and forms. We are a distributor for more than 50 companies which allows us to offer a complete line of many products. These products range from stock and custom medical labels and tapes, laser and thermal labels, pharmacy supplies, paper and plastic bags, unit dosing systems, advertising products and much more.



Looking for something not shown in our catalog? Give us a call, we would be happy to find it for you.

Thank you for taking the time to look through our catalog and please know that we will work hard to earn your business by having a helpful office staff, knowledgeable sales force and offering the best service in the industry. We sincerely thank you for the opportunity to serve you.



Your Friends at Jays Company

Packaging

General Information	4
Custom Printed Paper Bags	5
Stock Pharmacy Paper Bags	6
Stock Miscellaneous Paper Bags	7
Custom & Stock Plastic Bags	8
Packaging & Shipping Supplies	9
Mailing Labels & Stamps	12
Vials, Jars & Ovals	13
Unit Dose Pill Cards & Supplies	16
One-Piece Cold Seal Cards	17
Cold Seal Med Cards	18
Heat Seal Med Cards	19
One Piece Heat Seal Cards	20
Cold Seal 7x4 Trifolds	21
Dosis 31-Day Card.....	22
Dosis Specialty Labels	23
Opti-Pak System	24
Omnicell Accessory	26
Heat Seal Machine	27
Ezy Dose Cold Seal Unit Dose System	28

Forms & Supplies

Computer Statements & Envelopes
Custom Stationery, Envelopes, Business Cards
Checks
Register Forms, Sales Receipts, Charge Slips & Claim Forms
Med Sheets & Toners
Controlled Substance Books, Manuals and Supplies
Prescription Blanks
Prescription Files and Supplies
Prescription Label Tape/Pharmacy Dispensing Equipment
Graduates & Compounding Equipment
Name Badges, Name Plates & Signs
Custom Stamps
Storage Bins
Anti-Fatigue Floor Matting
Pharmacy Retrieval System

Advertising & Dosing Supplies

Promotional Advertising Specialties
Pens & Notepads
Magnets & Clips
Calendars & Wallet Cards
Travel & Health Items
Candy & Breath Fresheners
Drinkware & Outdoor Specialties
Bags & Totes
Dosing Supplies
Medical Alert Jewelry

Labels

Custom Rx Labels
Direct Thermal Label Options Retail
Thermal Rx Labels
Direct Thermal Label Options LTC
Long Term Care Labels
Laser Rx Labels (All Pressure Sensitive)
Laser Dual Web Rx Labels
Labels For Automated Systems (Robot)
Patient Compliance Labels
Specialty Labels
Hazardous Drugs
Miscellaneous Blank Labels
Mailing Labels
Veterinary Labels

General Information

Artwork Requirements

We accept artwork and logos via email. Artwork must be created in one of the Adobe programs listed below. Other programs may be used providing they can export output which can be read by these programs. Note: files created by “paint” programs are not usable.

Adobe Illustrator: Versions

EPS

Photoshop PSD

Adobe PDF

JPEG

Proofs on Printed Orders

A proof on all new orders will be sent to you via email, fax or postal mail. When proofing, please be sure that you check all spelling, logos, punctuation, phone numbers and placement of copy. We cannot be responsible for orders approved by the customer that contain incorrect copy.

Shipping

If no specific carrier is requested, then all merchandise is always shipped in the most affordable and reliable way. Many items are stocked in our warehouse and will ship within 24 hours.

Damaged Shipments

Although we work hard to ensure that all shipments are received without damage, it does sometimes occur. Upon receiving, all orders should be checked for damage. All claims for damaged merchandise should be filed with the carrier. If you receive a shipment that is damaged, sign for the shipment noting all damages on the signature page. Then contact Jays Company so we can assist with the claim process.

Return Policy

Please call us if you receive merchandise or items that you wish to return. We will make arrangements at that time and you will be given an RMA number (Return Merchandise Authorization). A restocking fee may apply to stock merchandise.

Sales Tax

All taxable merchandise will be subject to state and local sales taxes.

Custom Pharmacy Bags

Get your name out there with custom pharmacy paper bags. Name recognition and logo identification are key elements in defining who you are to your customer.

Top Reasons to Use Custom Bags



CUSTOM PAPER BAG SIZES

Card Bag

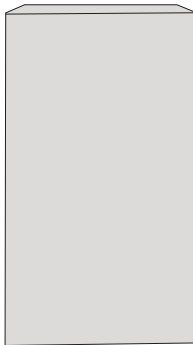

6" x 9"
3,000/cs
12,000 Minimum

7" x 10"
3,000/cs
12,000 Minimum

Gusset

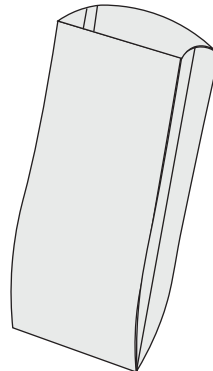

3 1/2" x 1 1/2" x 10"
3,000/cs
12,000 Minimum

5" x 2" x 10"
3,000/cs
12,000 Minimum

Flat Bottom SOS Bag



6lb
6" x 3 5/8" x 11"
1,000/cs
6,000 Minimum

12lb
7" x 4 1/4" x 13 1/2"
1,000/cs
3,000 Minimum

20lb
8" x 5" x 16"
3,000/cs
12,000 Minimum

It's easy and simple. Let our friendly staff assist you in creating a custom pharmacy bag. Call or email a Jays Company representative to learn more.

A custom bag Quote Request Form can be found on the back page of this catalog or by emailing sales@jayscompany.com.

Stock Pharmacy Bags

Your choice of 7 sizes and 4 styles,
1 case minimum.
Our stock pharmacy bags ship within 24 hours.

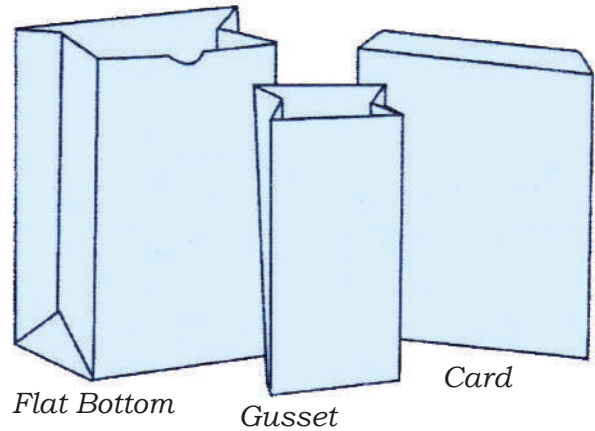

Gusset Prescription Bags

Size	Qty/Case	Rx Store Front	Apothecary	Mortar & Pestle	Standard
3 1/2" x 1 1/2" x 10"	2,000	RXBAG3210	SPB3A	SPB3	SB3
5" x 2" x 10"	2,000	RXBAG5210	SPB5A	SPB5	SB5

Card Bags

Size	Qty/Case	Rx Store Front	Apothecary	Mortar & Pestle	Standard
7" x 10"	2,000	N/A	SPB7A	SPB7	SB7
9" x 12"	2,000	N/A	N/A	N/A	SB9

Flat Bottom

Size	Qty/Case	Rx Store Front	Apothecary	Mortar & Pestle	Standard
6LB 6" x 3 5/8" x 11"	1,000	RXBAG6LB	SPB6A	SPB6	SB6
12LB 7" x 4 1/4" x 13 1/2"	1,000	RXBAG12LB	SPB12A	SPB12	SB12
20LB 8" x 5" 16"	Varies	RXBAG20LB	N/A	N/A	SB20

When ordering in large quantities you may want to consider custom printed bags. Please call for details.



Rx Store Front



Apothecary



Standard and Mortar & Pestle

Seasonal Bags Are Available (choose from 10 colorful designs)



Grocery-Style Bags

Natural Brown Kraft or White Kraft Paper Bags



Natural	White	Size	Qty	Dimensions
BKBJ2	WSQJ2	#2	500	4 1/8" x 2 5/8" x 7 3/16"
BKBJ4	WSQJ4	#4	500	5" x 3 1/8" x 9 3/4"
BKBJ6	WSQJ6	#6	500	6" x 3 5/8" x 11 1/16"
BKBJ8	WSQJ8	#8	500	6 1/8" x 4 1/8" x 12 1/2"
BKBJ12	WSQJ12	#12	500	7" x 4 1/2" x 14"
BKBJ16	WSQJ16	# 1/6 BBL	500	12" x 7" x 17"
BKBJ20	WSQJ20	#20	500	8 1/4" x 5 1/4" x 16 1/8"



Shopping Bags



All Paper Shoppers are biodegradable & recyclable. They are manufactured using water-based glue.

Bag Boutique

A wide variety of sizes and style selection of boutique gift bags. Including, but not limited to: Euro, Northwoods, Manhattan, Sophie, Mod and Rainforest.

Please contact Jays Company for more information.



Custom Printed and Plain Plastic Bags

Custom printed Eco-Friendly plastic bags is advertisement at its best! We offer a wide selection of popular sizes and styles. Our graphics team works directly with the production department to ensure the quality of your branding. We carry an impressive collection of stock plastic bags to fit your health care product packaging needs. Regardless of your demand, our team will provide you with the quality, delivery and follow up you deserve as our customer.

Top Reasons to Use Custom Bags

Branding Opportunity

Marketing Affiliation

Promote Free Delivery

Ease of Ordering w/ QR Code

Promote Multiple Locations

Advertising

Highlight Your Branding Message



T-shirt Bag



Die Cut Bag

Choose stock bags in many colors, styles and patterns or really step up your brand with customized bags. Call us today to let the fun begin!



Wave Top Bag



Patch Handle Bag



Merchandise Bag



Soft Loop Handle Bag

Plastic Bags - High and Low Density

We have many sizes, colors and prints available. Please call Jays Company for details.

Thank You T-Shirt Plastic Bag

Size	Qty/Case
9" x 6" x 16"	1,000
9" x 6" x 18"	1,000
12" x 7 1/2" x 22"	1,000
13" x 8" x 26"	1,000



Kraft Bubble Cushioned Mailers

These lightweight Kraft bags can be used for prescription mailing. Made of recycled materials, they weigh less than padded bags, resulting in approximately 20% savings in postage.

Self Sealing, they require no additional closure.



Item	Size	Qty/Case
JLJS000	4" x 8"	500
JLJS00	5" x 10"	500
JLJS0	6" x 10"	250
JLJS1	7 ¼" x 12"	100
JLJS2	8 ½" x 12"	100
JLJS3	8 ½" x 14 ½"	100
JLJS4	9 ½" x 14 ½"	100
JLJS5	10 ½" x 16"	100
JLJS6	12 ½" x 19"	50
JLJS7	14 ¼" x 20"	50

White Poly Bubble Mailers

These unique, lightweight protective padded white mailers are made from a durable, moisture resistant blend of polyethylene film.

The exterior film is laminated to a resilient interior for cushioning and is constructed with strong side heat seals for bursting strength. The bright white exterior provides a professional image. The pressure sensitive hot melt (self seal) adhesive closure system is reliable, tamper-evident and easy to use.



Item	Size	Qty/Case
AJJ000	4" x 7"	500
AJJ00	5" x 9"	250
AJJ0	6" x 9"	250
AJJ1	7 ¼" x 11 ¼"	100
AJJ2	8 ½" x 11 ¼"	100
AJJ3	8 ½" x 13 ¾"	100
AJJ4	9 ½" x 13 ¾"	100
AJJ5	10 ½" x 15 ¼"	100
AJJ6	12 ½" x 18 ¼"	50

Insulated Shippers

Cool Shield Bubble Mailers

Ship perishable or temperature-sensitive items in these mailers

- Bubble lining protects contents from damage while outer thermal material maintains temperature.
- Peel and seal strip for secure closure.
- Puncture-resistant and water-repellent. Material is lightweight and durable.



Expansion White Poly Mailers

Strong, polyethylene mailers protect products from moisture during shipping.

- Features a gusseted bottom to allow for thicker items such as binders, books and catalogs.
- Puncture, moisture, tamper and tear-resistant.
- High strength seams will keep contents intact even if over packed.
- The outer surface of the mailer is white and the inner lining is silver.
- Labels, ink and stamps adhere well.
- Self-seal closure with a double perforation tear strip for easy opening.

Available sizes:

6" x 9" - 1,000 per case

12.5" x 15.5" - 500 per case



Insulated Shipping Box

Safely ship perishables or medical specimens requiring insulation. Tight fitting lid and seamless molded polystyrene body help maintain a constant cool temperature. Corrugated box is preassembled around foam insert for added durability. Wall thickness is 1-1/2".



Related Products

ICE-BRIX cold packs



Reclosable Plastic Bags

Listed are the most common sizes of 2 mil clear reclosable plastic bags. Other sizes are available. In addition, we offer a wide variety of reclosable and open ended poly bags in various grades and sizes including pill crusher pouches.

Item	Size	Qty/Case
RDA13	2" x 3"	1,000
RDA16	3" x 4"	1,000
RDA17	3" x 5"	1,000
RDA18	4" x 4"	1,000
RDA19	4" x 6"	1,000
RDA26	6" x 8"	1,000
RDA27	6" x 9"	1,000

Item	Size	Qty/Case
RDA28	8" x 8"	1,000
RDA29	8" x 10"	1,000
RDA30	9" x 12"	1,000
RDA31	10" x 13"	1,000
RDA32	12" x 12"	1,000
RDA42	13" x 15"	1,000



Many other sizes available.

Specialty Bags

Narcotic Return
Blue "Refrigerate"
Blue "PRN"
Red "STAT"

Orange "PRN"
Caution-Dosage Strength Different
Orange Block
Medication Transfer Bag

Tinted (Blue or Pink)
Crash Cart/Drug Tray Security
Clear Tamper Evident
Infuser Syringe Bags
USP800 Transport Bags



Shipping Tape and Dispenser

Transparent tape adheres instantly to nearly any material. Dispensers available for all sizes.

3M™ Tape

Item	Size	Qty/Case
3M1	1"	Each
3M15	1½"	Each
3M175	1¾"	Each
3M2	2"	Each

Generic Tape

Item	Size	Qty/Case
TAPE1X72	1"	Each
TAPE1.5X72	1½"	Each
TAPE1.75X72	1¾"	Each
TAPE2X72	2"	Each



Tape Dispenser

Item	Qty/Case
C22	Each



Mailing Labels

Blank or personalized mailing labels, 16 different designs to choose from. Price includes one standard ink color (black, red, yellow, blue, or green). No additional charge to typeset up to 4 lines of copy. Minimum quantity is 250.

Present a professional image for instant recognition of your packages! Call and order your labels today!



Laser Sheets

White matte laser stock
Excellent image quality
8-1/2" x 11" sheet 6-up
For laser printers
Each individual measures
3-1/3" x 4"

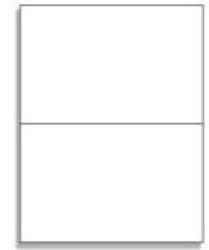

2-Up Shipping Label

Each individual measures
8-1/2" x 5 1/5"

Shipping Labels

	Item	Size	Qty/Case
Thermal	4X6SHIP-J	4" x 6"	12 rolls (250/roll)
Laser	2UP-SHIPPING	8 1/2" x 11"	250/pack



4x6 Shipping Label

Self-Inked Stamps

Self-Inked, Pre-Inked and Rubber Stamps

Square, round and rectangle stamps available in a variety of sizes. Ink colors include blue, purple, red, green and black.

We also offer pre-inked, rubber and notary stamps. To support the stamps, we offer re-inking systems and pads.



JAYS COMPANY
P.O. BOX 309
14400 JAMES RD, SUITE A
ROGERS, MN 55374-0309

Red "C" and "N" Stamps

Item	Description
JCST	C Stamp - Red
JCSTII	CII Stamp - Red
JNST	N Stamp - Red

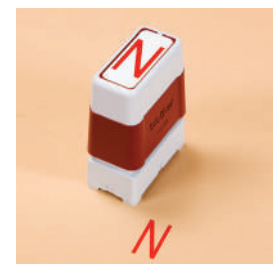

Speak with a Jays Company representative about custom stamps.

Secure Advantage, Secure Reversible, Berry Friendly and Safe

Free Custom Imprinting - Prepaid freight on orders of 2 cases or more

Keep your pharmacy name in front of your customers with **FREE** custom cap imprinting.

Contact a Jays Company representative for more information.



Secure Advantage Vials Only

Item	Size	Qty/Case
V8608	8 dram	550
V8613	13 dram	400
V8616	16 dram	320
V8620	20 dram	256
V8630	30 dram	210
V8640	40 dram	144
V8660	60 dram	98

Secure Advantage Child-Resistant Caps

Item	Size	Caps/Bag	Qty/Case Bags/Case
VSASCR8	8 dram	300	2400/8
VSASCR13	13/16 dram	200	1800/9
VSASCR20	20 dram	150	1050/7
VSASCR30	30 dram	100	800/8

Secure Advantage Snap Caps

Item	Size	Caps/Bag	Qty/Case Bags/Case
VSASSC8	8 dram	300	300/11
VSASSC13	13/16 dram	200	2200/11
VSASSC20	20 dram	150	1350/9
VSASSC30	30 dram	100	1100/11

Secure Reversible Cap Vials

Item	Size	Qty/Case
V8808	8 dram	410
V8813	13 dram	275
V8816	16 dram	220
V8820	20 dram	270
V8830	30 dram	210
V8840	40 dram	160
V8860	60 dram	115

Secure Liquid Ovals

Item	Size	Qty/Case
V8201	1 oz.	200
V8202	2 oz.	100
V8203	3 oz.	100
V8204	4 oz.	100
V8206	6 oz.	50
V8208	8 oz.	50
V8212	12 oz.	50
V8216	16 oz.	50

Berry Perfect Pack Vials - Snap Caps

Item	Size	Qty/Case
V4208	8 dram	450
V4212	12 dram	300
V4216	16 dram	250
V4230	30 dram	130
V4240	40 dram	95

Berry Plastic Liquid Oval Containers

Please specify Child Resistant "CR" or Non-Child Resistant "N"

Item	Size	Qty/Case
V7202	8 dram	450
V7203	12 dram	300
V7204	16 dram	250
V7206	20 dram	175
V7208	30 dram	130
V7212	40 dram	95
V7216	40 dram	95



Prefer Screw Top Vials and Ovals

Color Coding Available in Blue, Green and Amber

Vials

Item	Size	Qty/Case
VSP47008	8 dram	490
VSP47011	11 dram	400
VSP47013	13 dram	275
VSP47016	16 dram	272
VSP47020	20 dram	196
VSP47030	30 dram	165
VSP47040	40 dram	126
VSP47050	50 dram	105

Liquid Ovals

Item	Size	Qty/Case
VSP31602	2 oz.	200
VSP31603	3 oz.	200
VSP31604	4 oz.	200
VSP31606	6 oz.	100
VSP31608	8 oz.	100
VSP31612	12 oz.	100
VSP31616	16 oz.	50

Child resistant caps included on the vials. Non-lock caps also available.



Berry Ointment Jars

Item	Size	Qty/Case
V5900	1/2 oz.	12
V5901	1 oz.	12
V5902	2 oz.	12
V5904	4 oz.	12
V5908	8 oz.	12
V5916	16 oz.	12

Berry Standard Pack Child Resistant Prescription Vials

10% of non-lock snap caps included.

Item	Size	Qty/Case
V3108	8 dram	400
V3112	12 dram	270
V3116	16 dram	230
V3120	20 dram	180
V3130	30 dram	120
V3140	40 dram	100
V3160	60 dram	60

Berry PerfectPak Vials

Item	Size	Qty/Case
V3608	8 dram	500
V3612	12 dram	325
V3616	16 dram	270
V3620	20 dram	200
V3630	30 dram	140
V3640	40 dram	110
V3660	60 dram	70

Berry PerfectPak Non-Lock Snap Caps

Item	Size	Qty/Case
VPPSC8	8 dram	300
VPPSC12	12/16/20 dram	200
VPPSC30	30/40/60 dram	100

Berry PerfectPak Child Resistant Caps

Item	Size	Qty/Case
VPPCRC8	8 dram	300
VPPCRC12	12/16/20 dram	200
VPPCRC30	30/40/60 dram	100

Berry Friendly & Safe Vials

Vials and caps sold separately.

Item	Size	Qty/Case
V6609	9 dram	475
V6613	13 dram	325
V6616	16 dram	270
V6620	20 dram	200
V6630	30 dram	140
V6640	40 dram	110
V6660	60 dram	70

Berry Friendly & Safe Amber Child-Resistant Caps

Item	Size	Qty/Case
VFSCR9	9 dram	250
VFSCR13	13/16 dram	200
VFSCR20	20 dram	150
VFSCR30	30/40/60 dram	100

Berry Friendly & Safe CHOICE Reversible Caps

Item	Size	Qty/Case
VFSCH13	13/16 dram	450

Berry Friendly & Safe Non-Lock Snap Caps

Item	Size	Qty/Case
VFSSC9	9 dram	300
VFSSC13	13/16 dram	200
VFSSC20	20 dram	150
VFSSC30	30/40/60 dram	100

SureMed by Omnicell Guided Packing

This cloud-based software can be accessed from any workstation within the pharmacy, providing greater options and flexibility to meet customer demand. This application works in conjunction with SureMed by Omnicell multimed adherence blister cards.

Recommended Accesories:

- HP PageWidePro 750DW Printer #B09-00-00-403
- Epson WF-8090 Printer #A-0590A
- SureMed by Omnicell 7x4 Bi-Fold, Cold Seal, Perforated Cards #J300-96 or #J301-96
- Coordinating blisters #J206-37 or #J206-39
- Template #J584-31 or #J584-30
- Roller #J660-00



Contact Jays Company Representative For More Information.

Branded vs Co-Branded

7x4 Bi-Fold, Cold Seal, Perforated 250/Case
 Item #300-96

Recommended Accessories:

- HP PageWidePro 750DW Printer #B09-00-00-403
- Epson WF-8090 Printer #A-0590A
- SureMed by Omnicell Guided Packing Software #MTS-SWS-001
- Template #584-31 (image in page 17)
- Roller #660-00

Coordinating Blisters, 250/Case

Item No.	Description
206-37	SureMed Standard Blister

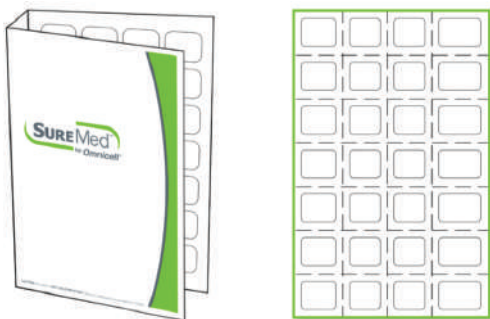

7x4 Bi-Fold, Cold Seal, Perforated 250/Case
 Item #300-96CB Co-Branded Option

Recommended Accessories:

- HP PageWidePro 750DW Printer #B09-00-00-403
- Epson WF-8090 Printer #A-0590A
- SureMed by Omnicell Guided Packing Software #MTS-SWS-001
- Template #584-31 (image in page 17)
- Roller #660-00

Coordinating Blisters, 250/Case

Item No.	Description
206-37	SureMed Standard Blister

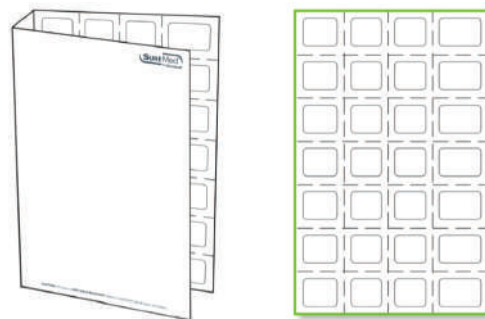

Omnicell One-Piece Cold Seal Cards



This card comes ready-to-go. Simply place meds in the blisters, peel the protective paper of the card and flap it over to seal the card.

31-Day Cold Seal

Item #J300-40

31 Dose Card w/ Large Blister

Coordinating Cork:
#JCORK-30

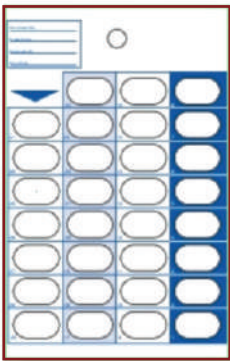

62-Day Cold Seal

Item #J300-41

62 Dose Card

Coordinating Cork:
#JCORK-60

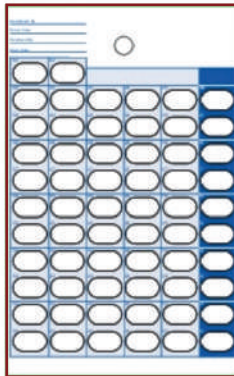

90-Day Cold Seal

Item #J300-42

90 Dose Card

Coordinating Cork:
#JCORK-90

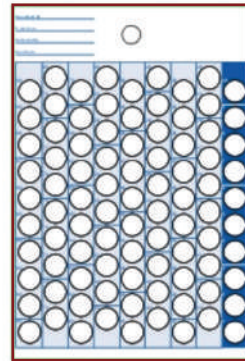

Corks

Item #JCORK-30

30/31/32 Dose Cork

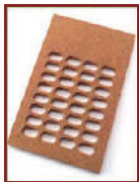

Item #JCORK-30A

30/31/32 Dose Cork
Deeper Blister



Item #JCORK-60

60/62 Dose Cork

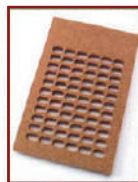

Item #JCORK-90

90 Dose Cork

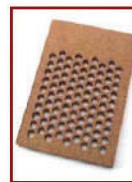

Item #J660-00

Cold Seal Roller



Templates

Item #584-31

7-Day/ 28-Dose Sealing
Template for 300-96



Item #584-30

7- Day/ 28- Dose Sealing
Template for 301-96





14-Day Item #314-61

250/cs

Coordinating Blisters- Unit Dose

Item No. Description
201-05 Large 14-Day

Coordinating Cork:
#655-30

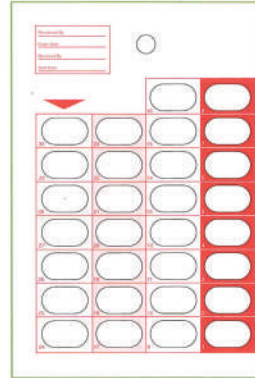

30-Day Item #300-39

250/cs

Coordinating Blisters- Standard

Item No. Description
200-27 Small
200-28 Medium
200-30 Large
200-51* Extra Large
203-29 Small Amber
203-32 Medium Amber
203-34 Large Amber

*Blister requires special triple layer cork to seal.

Coordinating Corks:
#655-30
#655-30A (Triple Layer Cork)

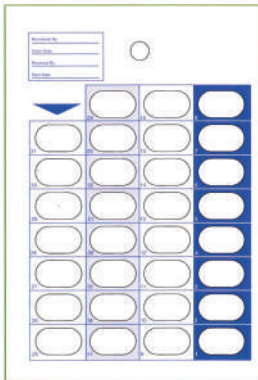

31-Day Item #300-58

250/cs

Coordinating Blisters- Standard

Item No. Description
200-31 Small
200-32 Medium
200-34 Large
200-52* Extra Large
203-30 Small Amber
203-31 Medium Amber
203-33 Large Amber

*Blister requires special triple layer cork to seal.

Coordinating Corks:
#655-30
#655-30A (Triple Layer Cork)

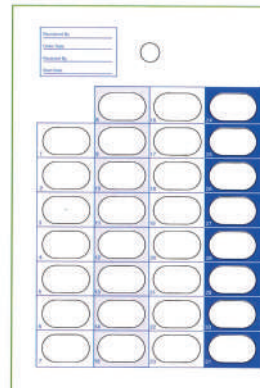

31-Day Calendar

Item #300-59

250/cs

Coordinating Blisters- Standard

Item No. Description
200-31 Small
200-32 Medium
200-34 Large
200-52* Extra Large
203-30 Small Amber
203-31 Medium Amber
203-33 Large Amber

*Blister requires special triple layer cork to seal.

Coordinating Corks:
#655-30
#655-30A (Triple Layer Cork)

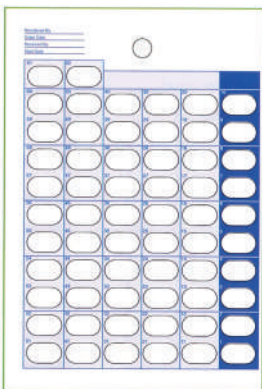

62-Day Item #300-64

250/cs

Coordinating Blisters- Standard

Item No. Description
200-23 62-Day
200-25 62-Day Amber

Coordinating Cork:
#655-60

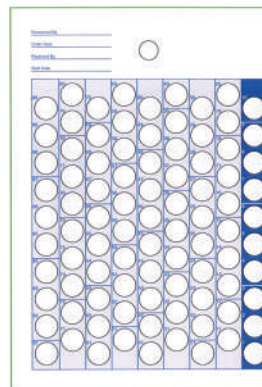

90-Day Item #300-65

250/cs

Coordinating Blisters- Unit Dose

Item No. Description
200-24 90-Day
203-26 90-Day Amber

Coordinating Cork:
#655-90

Standard and Amber Blisters

Small

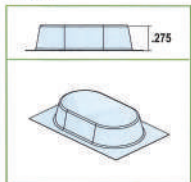

Medium

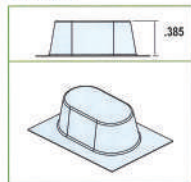

Large

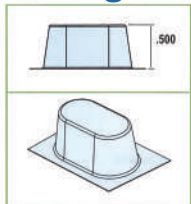

Extra Large

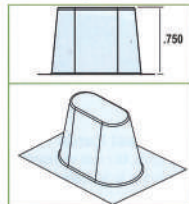

62 Day

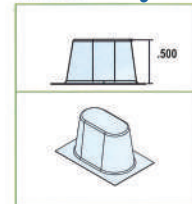

90 Day

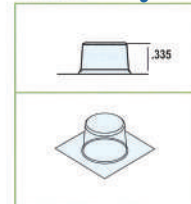

Omnicell Heat Seal Medication Cards

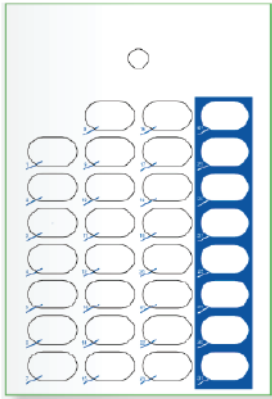

31-Day Item #300-16

500/cs

Coordinating Blisters- Standard

Item No.	Description
200-31	Small
200-32	Medium
200-34	Large
200-52*	Extra Large
203-30	Small Amber
203-31	Medium Amber
203-33	Large Amber

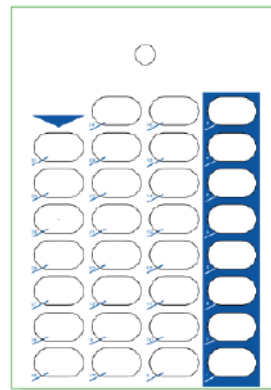

31-Day Item #300-25

500/cs

Coordinating Blisters- Standard

Item No.	Description
200-31	Small
200-32	Medium
200-34	Large
200-52*	Extra Large
203-30	Small Amber
203-31	Medium Amber
203-33	Large Amber

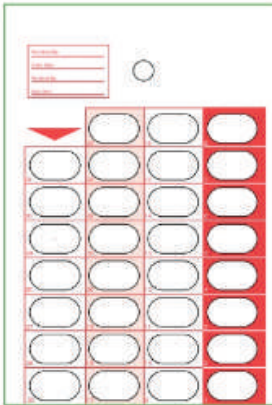

31-Day Item #302-15

500/cs

Coordinating Blisters- Standard

Item No.	Description
200-31	Small
200-32	Medium
200-34	Large
200-52*	Extra Large
203-30	Small Amber
203-31	Medium Amber
203-33	Large Amber

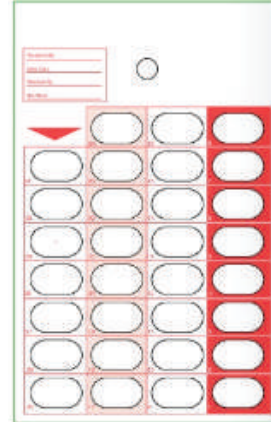

31-Day Narrow Item #302-14

500/cs

Coordinating Blisters- Standard

Item No.	Description
200-31	Small
200-32	Medium
200-34	Large
200-52*	Extra Large
203-30	Small Amber
203-31	Medium Amber
203-33	Large Amber

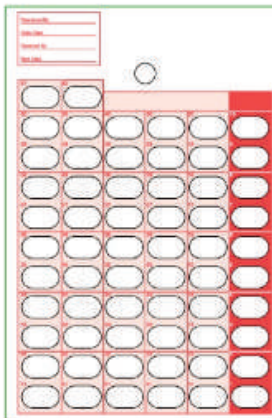

62-Day Item #302-11

500/cs

Coordinating Blisters- Standard

Item No.	Description
200-23	62-Day
200-25	62-Day Amber

**Blister requires special paddle.
Not to be used in Gemini.*

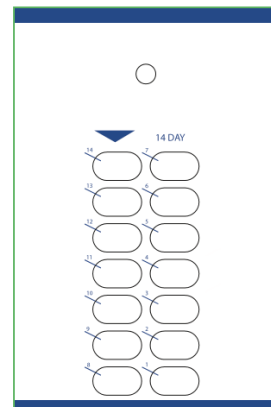

14-Day Item #314-51

500/case

Coordinating Blister:
J201-05 Large

Standard and Amber Blisters

Small

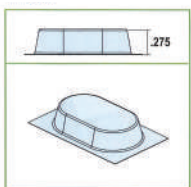

Medium

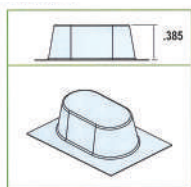

Large

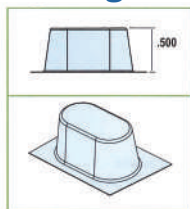

Extra Large

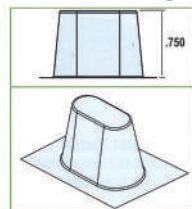

62 Day

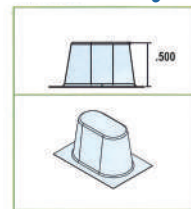

90 Day

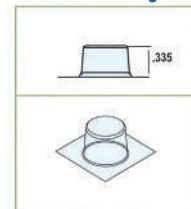

One-Piece Cards: A variety of our standard heat seal cards are also available with blisters already adhered to the card.

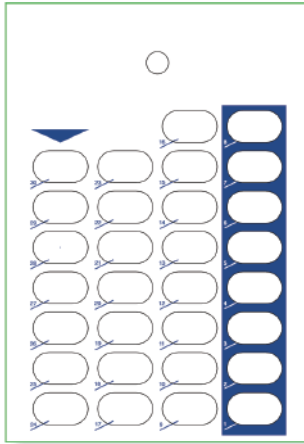

30-Day One Piece Cards

Item #:

J30M -Medium Blister
J30OV - Large Blister
J30OV/A -Large Amber

250/case

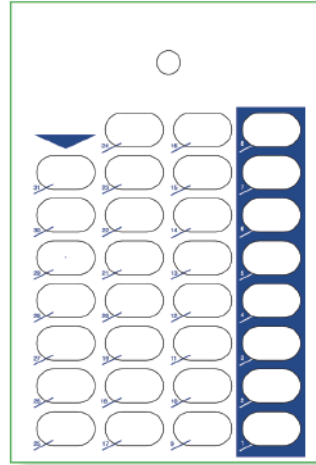

31-Day One Piece Cards

Item #:

J31S - Small Blister
J31M - Medium Blister
J31OV -Large Blister

250/case

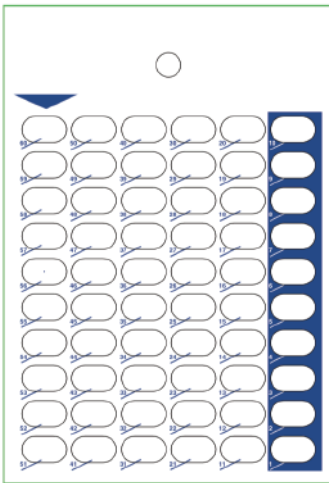

60-Day One Piece Cards

Item #:

J60 - 60 Day Blister

250/case

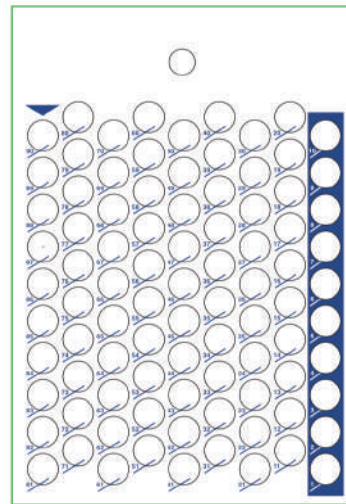

90-Day One Piece Cards

Item #:

J90 - 90 Day Blister

250/case

Item # 651-32
30/31/32 Dose
2-Up Paddle 5/8"



Item # 651-31
30/31/32 Dose
2-Up Paddle 7/8"



Item # 651-62
60/62 Dose
2-Up Paddle 5/8"



Item # 651-92
90 Dose
2-Up Paddle 5/8"



Omniceil Cold Seal 7x4 Tri-Folds



J301-25 7x4 Tri-Fold, Cold Seal with Standard Blister

- Pack includes:**
-250 cards
-250 blisters
-1 plastic template

Recommended Accessories:
Roller # J660-00



Cold Seal Roller

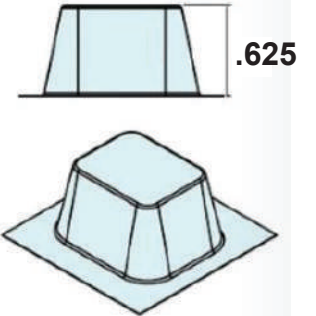
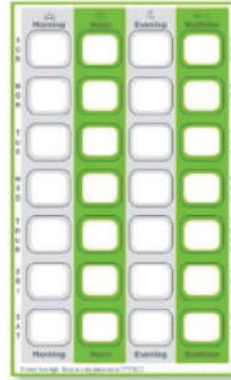

Blisters

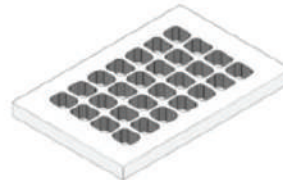

Plastic Template

J301-56 7x4 Tri-Fold, Cold Seal with Deeper Blister

- Pack includes:**
-250 cards
-250 blisters
-1 plastic template

Recommended Accessories:
Roller # J660-00

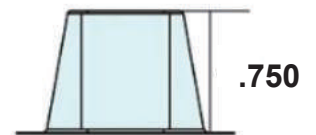
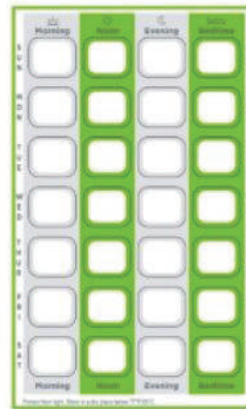
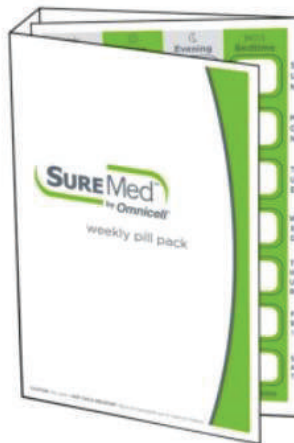

Blisters

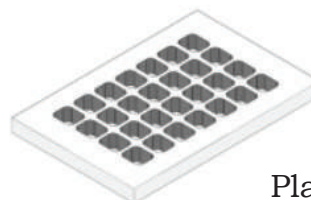

Plastic Template

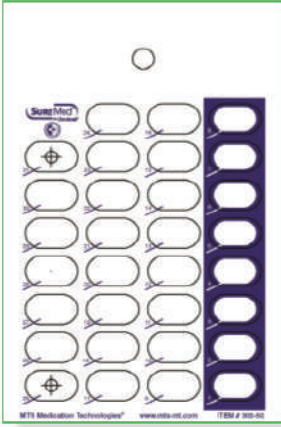

**31-Day Card
Item #300-50**

500/cs

**Description:
31 Front One-Piece/
Large Oval Blister Card**

Also available in medium blisters.

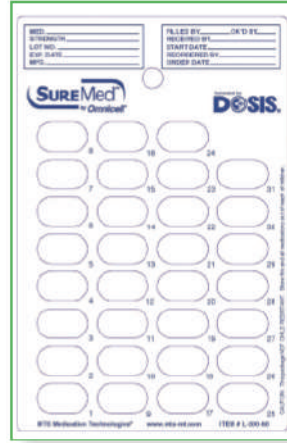

**31-Day Lidding
Item #L-300-50**

1,000/cs

**Description:
Lidding for back of #300-50**

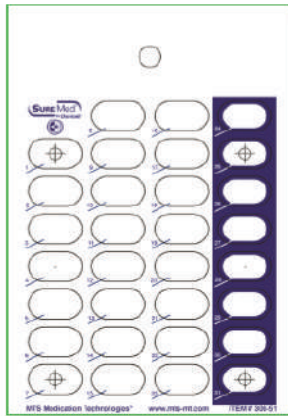

**31-Day Calendar Card
Item #300-51**

500/cs

**Description:
Calendar Style One-Piece/
Large Oval Blister Card**

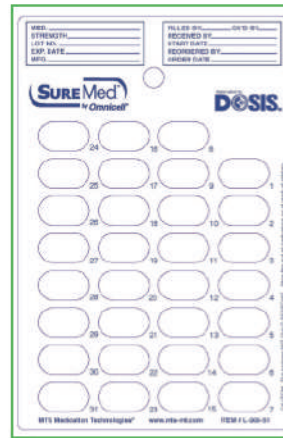

**31-Day Calendar
Card Lidding
Item #L-300-51**

1,000/cs

**Description:
Lidding for back of #300-51**

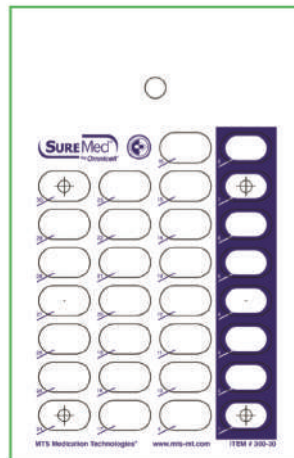

**30-Day Card
Item #300-30**

500/cs

**Description:
30 Front One-Piece/
Large Oval Blister Card**

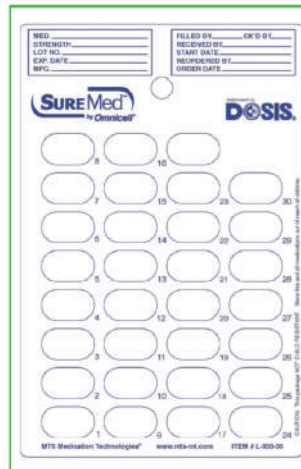

**30-Day Lidding
Item #L-300-30**

1,000/cs

**Description:
Lidding for back of #300-30**

Specialty Labels: DOSIS



Item #: DOSIS-52-J
 Size: 4" X 2" With Reorder Tab
 Paper: Direct Thermal (**No Perf Between Labels**)
 Finish: 1.5" cores, Rolled Inward, 4M/Box



Item #: DOSIS-53-J
 Size: 4" X 2" With Reorder Tab
 Paper: Direct Thermal (**Perf Between Labels**)
 Finish: 1.5" cores, Rolled Inward, 4M/Box



Item #: DOSIS-54-J
 Size: 4" X 2" No Reorder Tab
 Paper: Direct Thermal (**No Perf Between Labels**)
 Finish: 1.5" cores, Rolled Inward, 4M/Box



Item #: DOSIS-55-J
 Size: 4" X 2" No Reorder Tab
 Paper: Direct Thermal (**Perf Between Labels**)
 Finish: 1.5" cores, Rolled Inward, 4M/Box



Item #: L-300-56
 Size: 4" X 2" Four Color "Time Pass" DOSIS machine label with Reorder Tab
 Paper: Direct Thermal (**No Perf Between Labels**)
 Finish: 1.5" cores, Rolled Inward, 4M/Box

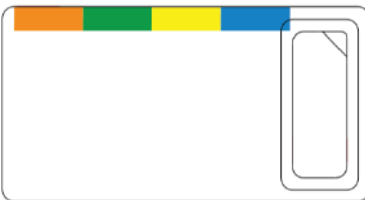

Item #: L-300-57
 Size: 4" X 2" Four Color "Time Pass" DOSIS Hand Applied label with Reorder Tab
 Paper: Direct Thermal (**Perf Between Labels**)
 Finish: 1.5" cores, Rolled Inward, 4M/Box

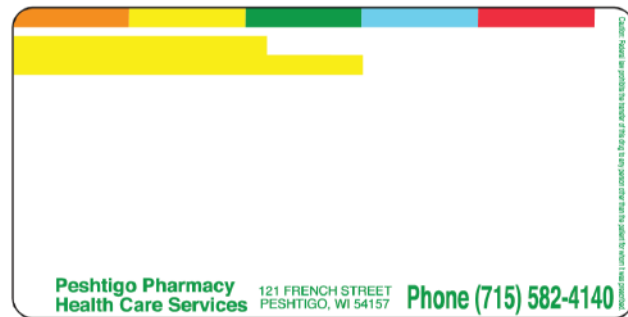

A disposable color-coded compliance package. The blister cards are available in 7/8 dose and 14/16 dose formats and are compatible with 3" medication cart drawers. The Opti-Pak is both tamper-evident and hygienic. The ability to automate the filling and sealing of the Opti-Pak product makes this system a viable compliance packaging solution for the pharmacy, home and resident.

Blisters

Opti-Pak comes with a standard blister.

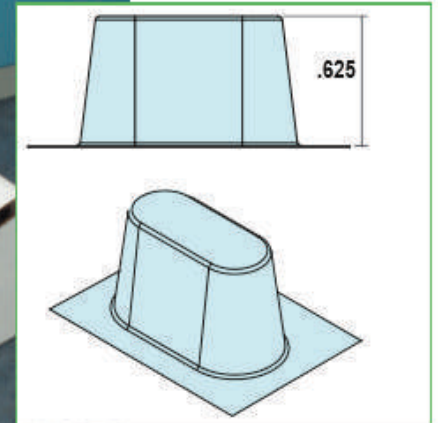

Opti-Pak Blister

Cards & Blisters, 1,000/Box

Item No.	Description
301-08	8/16-Day Heat Seal, Days of the Week
301-09	8/16-Day PRN Heat Seal, #'s 1-16

Blister
204-08
204-08

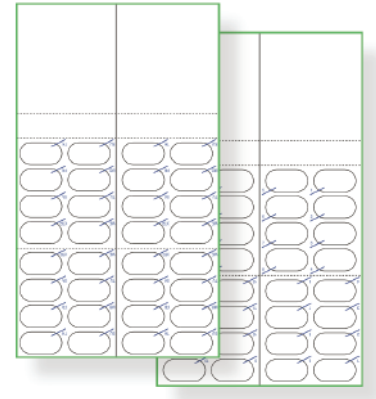

Recommended Accessories:

- Paddle #651-44

Storage Container, 100/Box

Item No.	Description
671-01	For 14/16 Day Cards



Item # 651-44

Opti-Pak Paddle 5/8" thick











Item # L-301-B1 thru L-301-B8
Opti-Pak - Color Coded Rx Labels

Size: 1 1/2" x 1"

Paper: Single Ply

Finish: Fanfold/ 5,000/Box

			
L-301-B1 Pink (7AM - 10AM)	L-301-B2 Yellow (11AM - 1PM)	L-301-B3 Green (2PM - 4PM)	L-301-B4 Orange (5PM - 7PM)
			
L-301-B5 Gray (8PM - 10PM)	L-301-B6 Purple (11PM - 6AM)	L-301-B7 Red (PRN)	L-301-B8 Blue (CONTROLLED)

Item # L-301-KIT

Time Pass Kit All Colors

Size: 1 1/2" x 1"

Paper: Single Ply

Finish: Fanfold/1,000/Color = 8,000/Box

Getting the right dose to the right customer has never been so easy

Multiple Blister Sizes

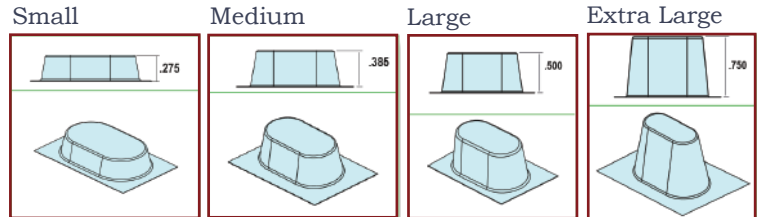
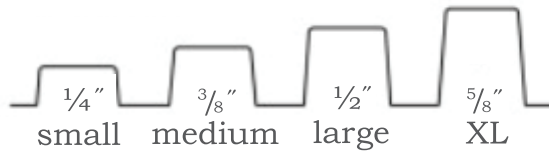

Corks Warning: Not to be used in heat sealers

Item # 655-30
30/31/32 Dose

Item # 655-30A
30/31/32 Dose
Deeper Blister

Item # 655-60
60/62 Dose

Item # 655-90
90 Dose

Item # 660-00
6" Cold Seal Roller



Paddles

Item # 651-32
30/31/32 Dose 2-Up
Paddle 5/8" thick

Item # 651-31
30/31/32 Dose
Do Not Use With
Gemini 7/8" thick

Cold-Seal Sealing Foam

Item # 657-31
31- Day Sealing Foam
for Multimed



Bin Boxes



Item #BIN-PILLCARD-SM
6-1/4" W X 9-5/8" D X 6" H
25 Boxes Per Pack



Item #BIN-PILLCARD-LG
8-1/4" W X 6" D X 8" H
25 Boxes Per Pack

HOTRONIX STX CLAM PRESS
With - Modified Handle
ITEM # NM-STX11MOD
***5 Year Warranty**

The 11" x 15" Hotronix Auto Opening Clam offers great value to any size business. The auto-opening feature has proven to be an excellent value, by increasing production to high volume users and small shops alike. The quick change lower platen and ability to accommodate various users to produce a variety of items with just one press.



Features:

- Magnetic auto-opening
- Unique modified handle
- Magnetic assist lock-down
- 3/4" thick Teflon coated heat platen
- Digital controls for temperature and time
- Platinum RTD heat probe reads platen temperature within 2 degrees
- 3/16" HRPO laser quality steel frame
- 3/8" Silicone rubber bottom pad
- Cast in tubular heating element every 2" to ensure no "cold spots"

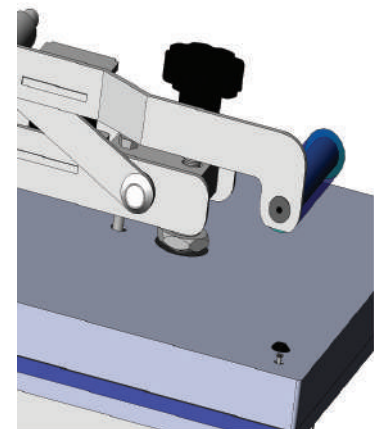

- Shipping Weight: 90 lbs.
- Shipping Dimensions: 31" x 20" x 20"
- 1750 watts, 14.5 amps
- Sealer Footprint: 29" L x 17" W x 16" H

* 5 year warranty on major components. 2 year warranty on the circuit board. Lifetime warranty on heating element.

Getting the right dose to the right customer has never been so easy

Ezy Dose® Cold Seal System

- Economic
- No electronic equipment needed
- Uses less storage space
- Vital for heat-sensitive medications
- Innovative no-fold design
- Lightweight, durable tray

Multiple Dosing Cards & Coordinating Blisters

Images on page 29

Multiple Blister Sizes

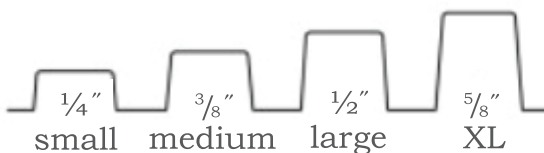

Ezy Dose Cold Seal Unit Dose System



A variety of configurations to meet your needs

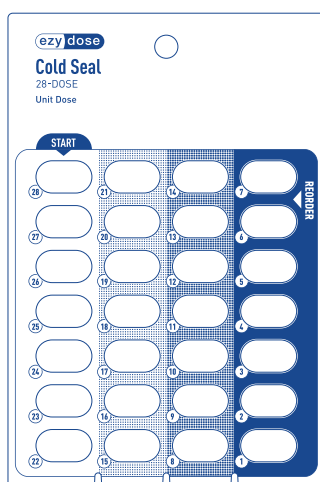
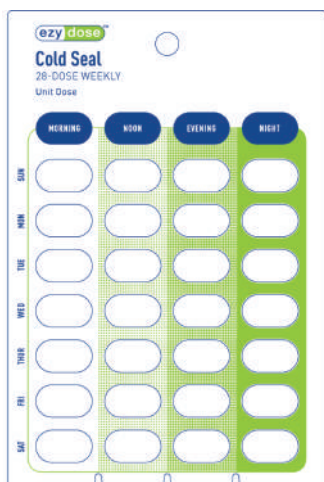

28 Dose

Item #	Description	Count
90700	Weekly card	500
90701	28-Dose card	500
90730	Blister - Small	500
90734	Blister - Medium	500
90738	Blister - Large	500
90742	Blister - XL	500
90675	28/31 Dose Tray	1
97599	Roller	1

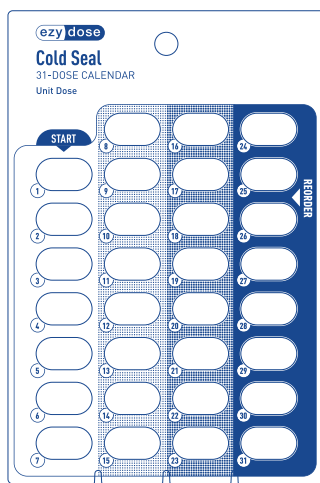
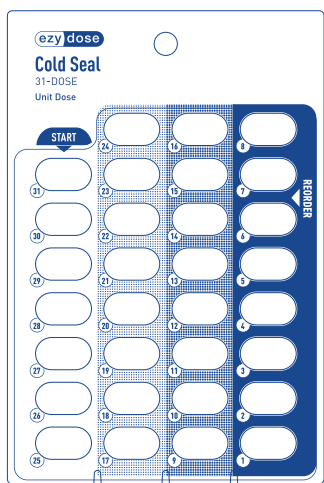

31 Dose

Item #	Description	Count
90703	31-Dose day card	500
90710	31-Dose calendar	500
90732	Blister - Small	500
90736	Blister - Medium	500
90740	Blister - Large	500
90744	Blister - XL	500
90675	28/31 Dose Tray	1
97599	Roller	1

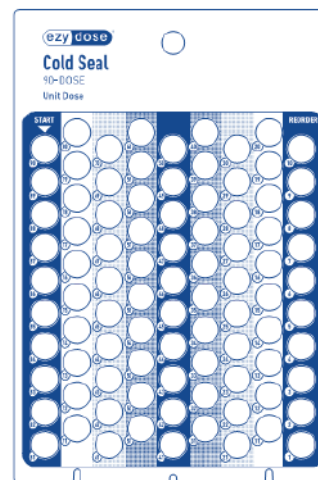
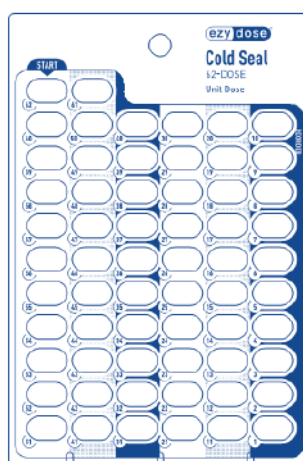
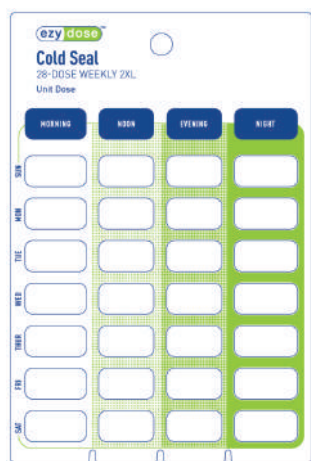

28 Dose - XXL

Item #	Description	Count
97612	28-Dose card	250
97625	Blister - XXL	250
97667	28-Dose XXL tray	1
97599	Roller	1

62 Dose

Item #	Description	Count
90705	62-Dose card	500
90751	Blister - Large	500
90676	62-Dose tray	1
97599	Roller	1

90 Dose

Item #	Description	Count
90707	90-Dose card	500
90757	Blister - Medium	500
90677	90-Dose tray	1
97599	Roller	1



NOTES

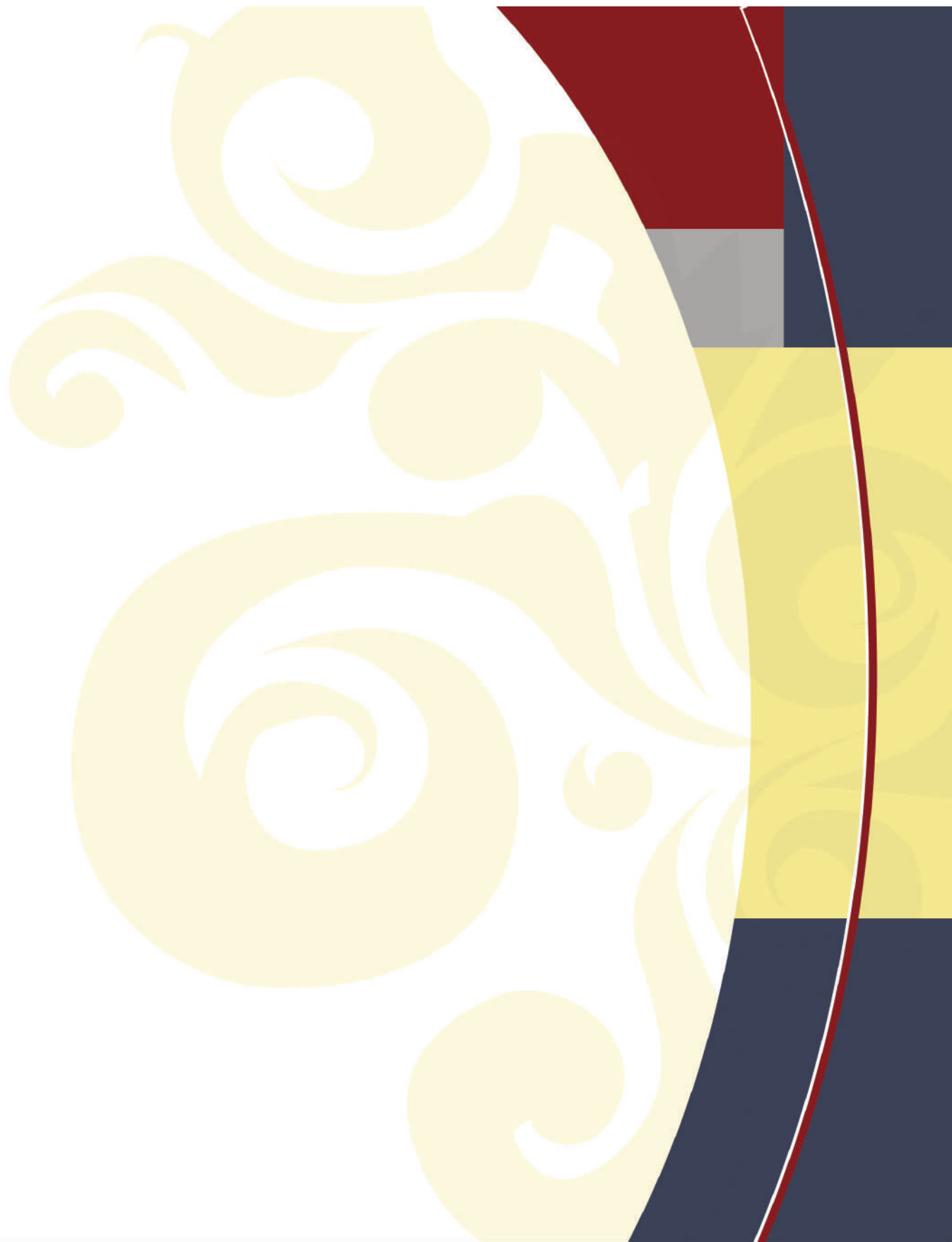

Jays Company
14400 James Road
PO Box 309
Rogers, Minnesota 55374-0309

1-800-647-5297 or 763-557-0056

Check us out on the web as well!
www.jayscompany.com